



**PML**<sup>®</sup> Arredamenti Ufficio  
**Sedute Operative**





## 1000 Grey

Poltrona operativa con schienale alto

### dotazioni standard

senza braccioli

meccanismo mod. Contatto P4

regolazione manuale dello schienale

alzata a gas

base mod. CG1 in nylon grigio

ruote gommiate

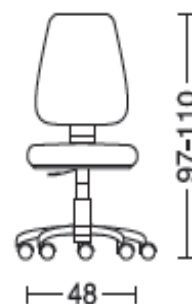



## Matrix 012

Poltrona operativa  
con schienale alto in rete

### dotazioni standard

senza braccioli

meccanismo oscillante bloccabile

regolabile in 4 posizioni,

alzata a gas

base mod. CG1 in nylon grigia

ruote gommatae

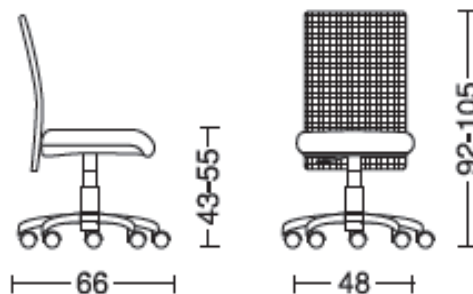

Normativa europea EN 1335



## SKILL

Poltrona operativa da ufficio, con schienale in rete. Skill è il risultato di una ricerca del massimo del comfort, caratteristica ormai irrinunciabile per una poltrona da ufficio.



### Skill 002

Poltrona operativa con schienale alto in rete  
Task armchair with high backrest in mesh

#### dotazioni standard

senza braccioli meccanismo mod. SY 6  
regolabile in 6 posizioni,  
traslatore integrato nel sedile,  
alzata a gas  
base mod. PN1 nylon nera  
ruote gommate

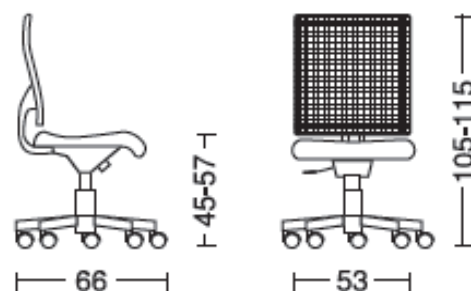

Normativa europea EN 1335



## Halley/net 02

Poltrona operativa con schienale alto in rete  
Task armchair with high backrest in mesh

### dotazioni standard

senza braccioli

meccanismo mod. SY5 regolabile in 5 posizioni

alzata gas

base mod. PN1 in nylon nero

supporto lombare regolabile

ruote gommatae

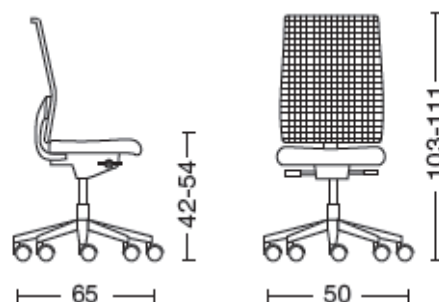

Normativa europea EN 1335



## Web/net 02

Poltrona operativa con schienale alto in rete  
e supporto lombare regolabile

### dotazioni standard

senza braccioli

meccanismo mod. SY5 regolabile in 5 posizioni

alzata gas

base mod. PN1 in nylon nero

supporto lombare regolabile

ruote gommatae



42-54



105-123

Normativa europea EN 1335



1300

Poltrona operativa con schienale alto  
Task armchair with high backrest

**dotazioni standard**

senza braccioli

meccanismo mod. Contatto P3

regolazione manuale dello schienale

alzata a gas

base mod. CN2 in nylon nero

ruote gommata

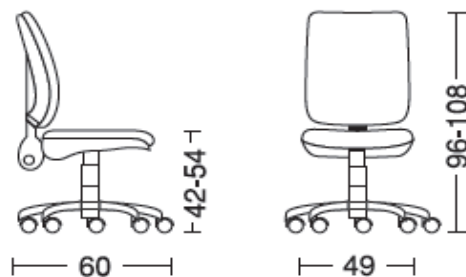

Normativa europea EN 1335

CATAS certificata DL 626/94



## Kit 100 BR GOLF

**Rivestimento:**  
tessuto fire retardant  
colori: rosso, nero e blu



### \*BR GOLF

Coppia braccioli  
Two armrests



rosso/red



nero/black



blu/blue



Kit 100

#### CARATTERISTICHE TECNICHE

SEDILE: pressato resinato a stampo

SCHIENALE: polipropilene rinforzato

CARTER ESTERNI: Polipropilene

IMBOTTITURA: espanso spessore cm 4 densita' 25 e 21 rc

BRACCIOLI: polipropilene rinforzato

MECCANISMO: contatto permanente con schienale regolabile in altezza

ELEVAZIONE: pompa a gas (certificata UNI 9084/86)

RUOTE: Ø 50 in poliammide

BASE GIREVOLE: arcata in nylon

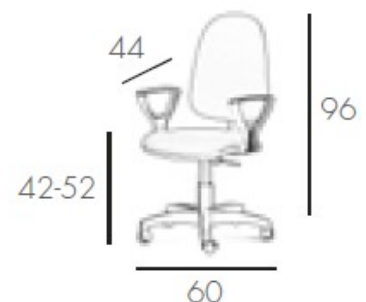

Peso netto/Net weight kg 12  
1 x box m<sup>3</sup> 0,11



*Joker*

**PML**<sup>®</sup>

*Joker*

CARATTERISTICHE TECNICHE

**RIVESTIMENTO:** sedile - pelle nera bi-cast con fasce in tessuto microforato nero. Schienale - rete nera.

**STRUTTURA:** sedile in legno multistrato pressato, schienale in acciaio

**IMBOTTITURA:** sedile espanso spessore cm 5,5 densità 30 rc

**SUPPORTO LOMBARE:** fisso in fibre elastiche

**BRACCIOLI:** fissi in polipropilene colore grigio

**MECCANISMO:** oscillante con bloccaggio nella posizione di lettura e manopola per la regolazione dell'intensità del movimento

**ELEVAZIONE:** pompa a gas (certificata UNI 9084/96)

**RUOTE:** diametro 50 in poliammide

**BASE GIREVOLE:** arcata in nylon colore grigio con finiture nere

**BASE FISSA:** tubolare diam. 25x2 verniciato grigio a polveri epossidiche con piedini anti ribaltamento



**Kit 10**

Peso netto/Net weight kg 12  
1 x box m<sup>3</sup> 0,10

45-55

64



## Smart 002

Poltrona operativa con schienale alto in rete

### dotazioni standard

senza braccioli

meccanismo mod. contatto permanente,

alzata a gas

base mod. PN1 nylon nera

ruote gommatae

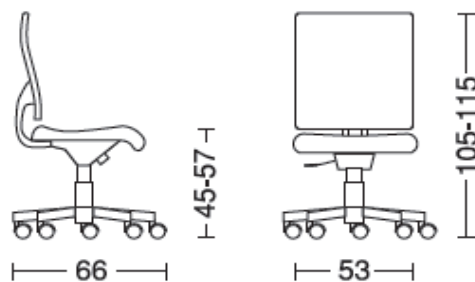

Normativa europea EN 1335